

10VA audio output transformer

Schematic

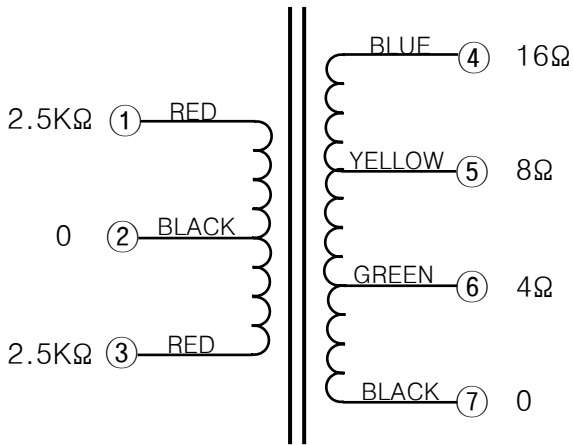

P/N: 2590A4

Power 10VA, Push Pull

Primary: 2.5KΩ-0-2.5KΩ

Secondary: 0-4Ω-8Ω-16Ω

Frequency response 20Hz-15KHz

Terminal Wire 150mm

Label

P/N: SY0910-2590A4	2009/12
PRI: 2.5KΩ-0-2.5KΩ	
RED-BLK.-RED	
SEC: 0-4Ω-8Ω-16Ω	
BLK.-GRN.-YEL.-BLU.	
Powered by www.dibao.com	

Dimension (mm)	L ≈	78
	W ≈	61
	H ≈	60
Weight (g)	≈700	

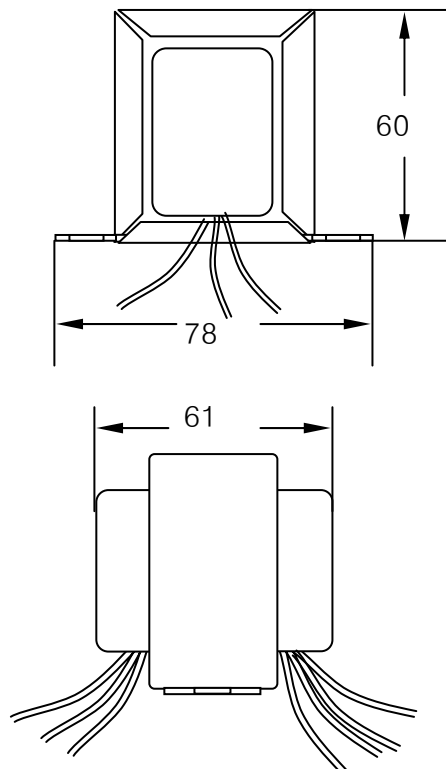

SY0910-2590A4 Frequency response

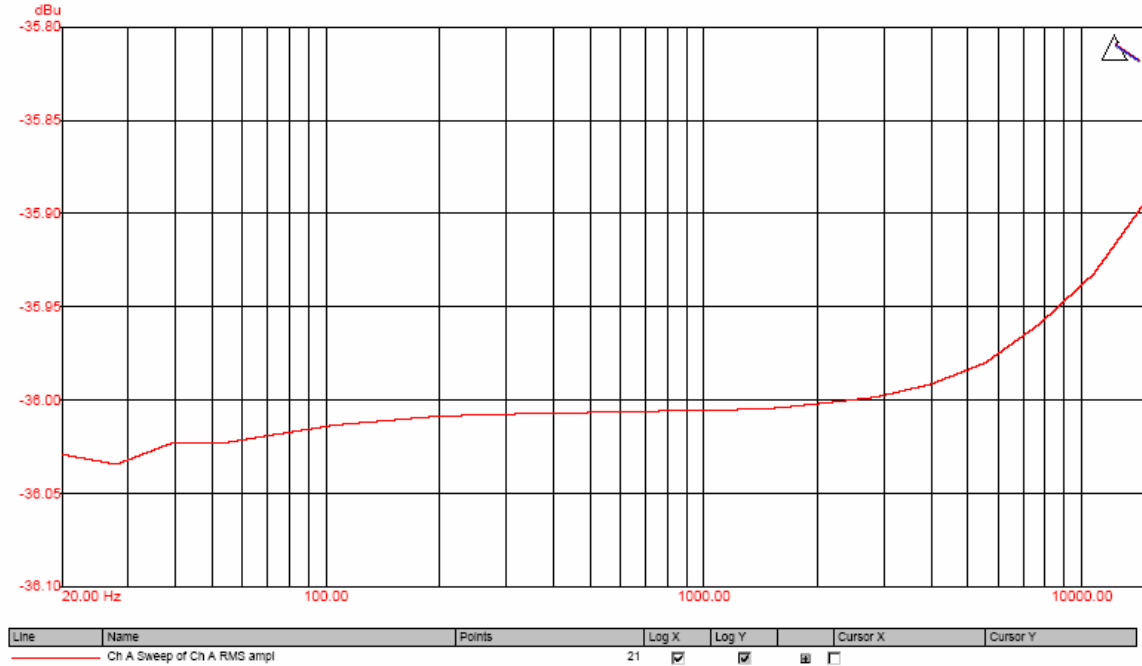

SY0910-2590A4 THD+N vs Frequency

